



IR U Series

Indoor LED display for Rental

P1.56,P1.9,P2.6,P2.9,P3.9,P4.8



90°



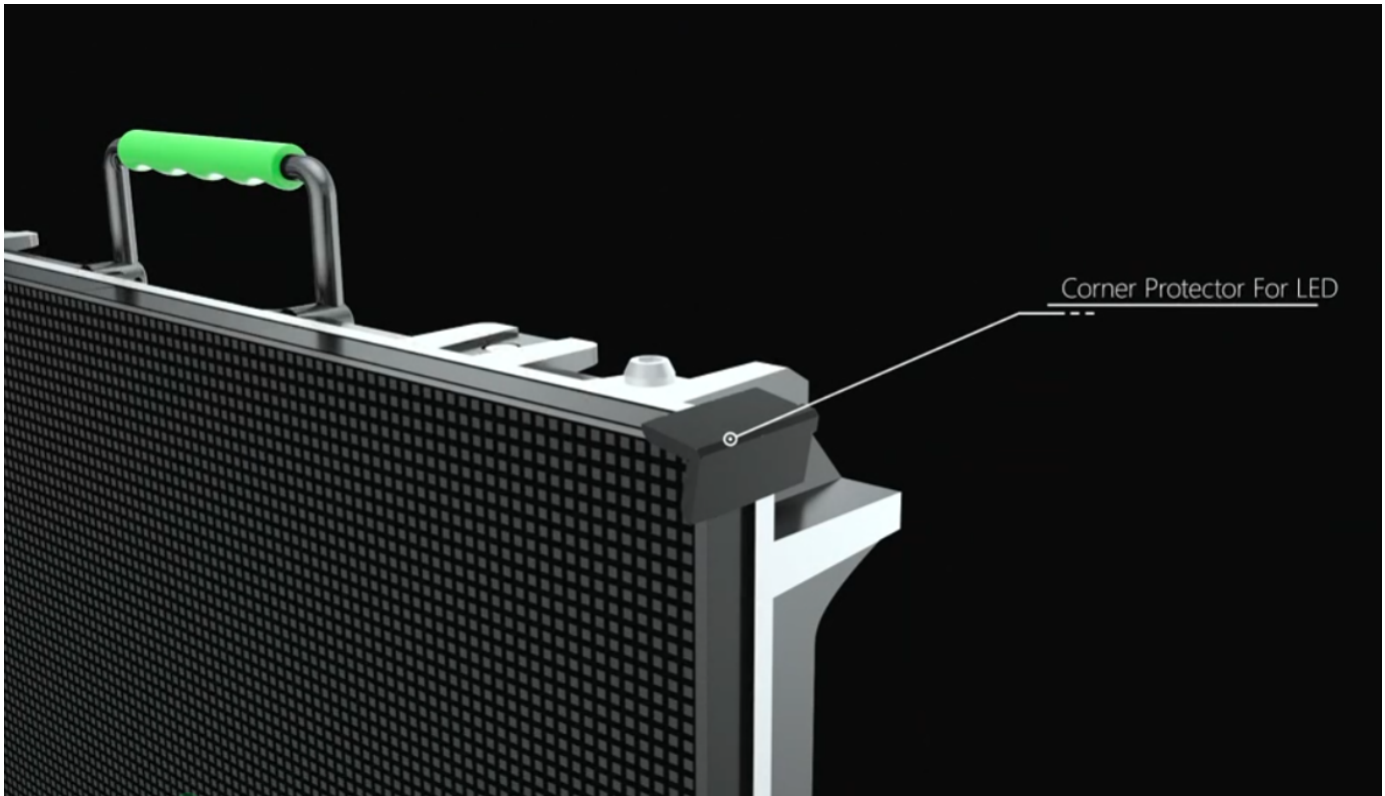
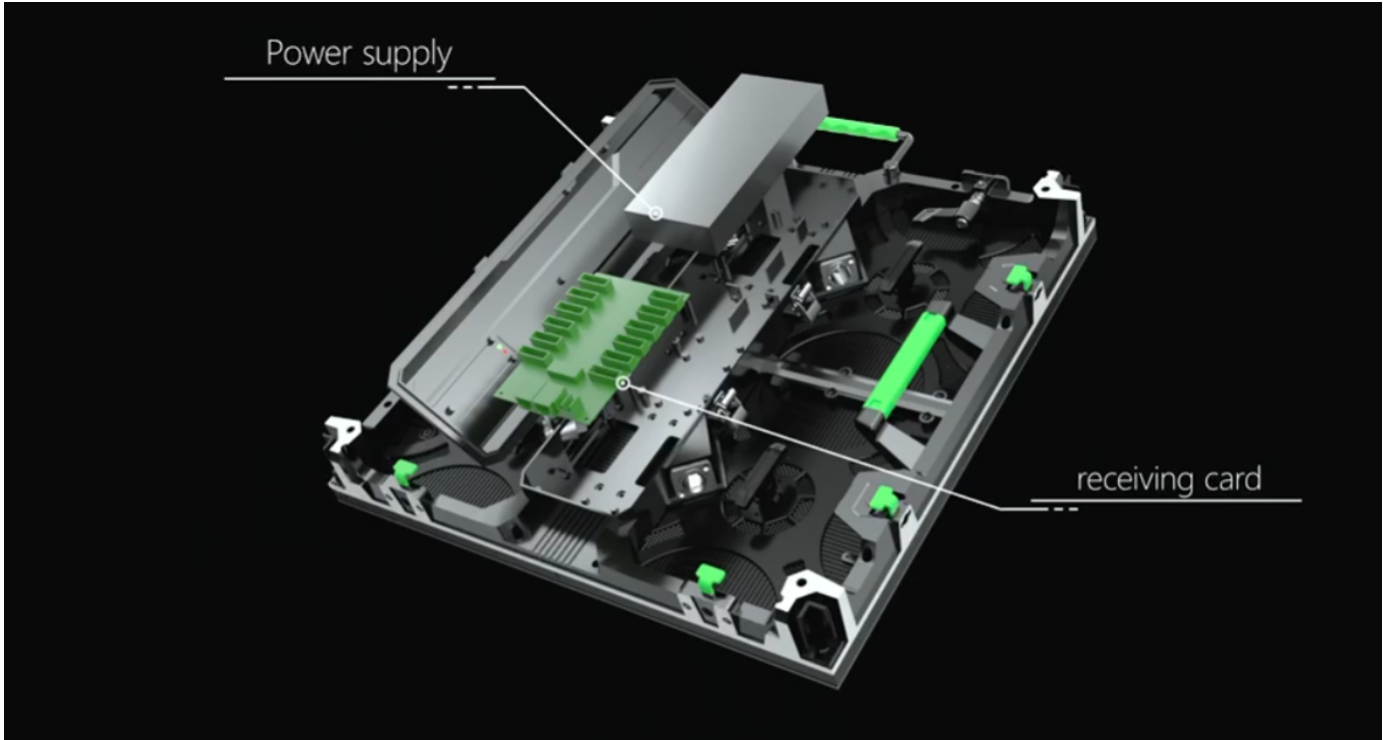

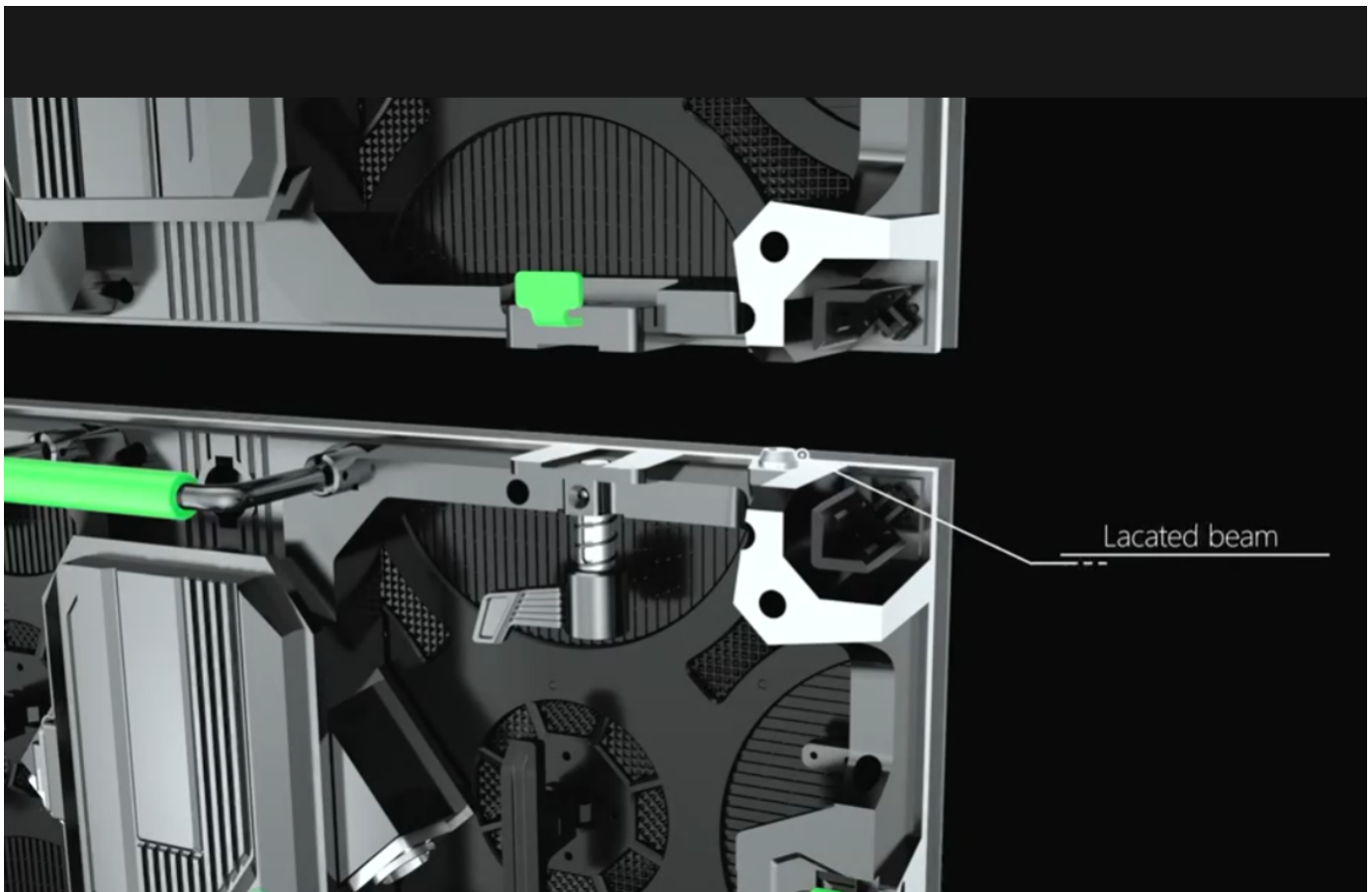
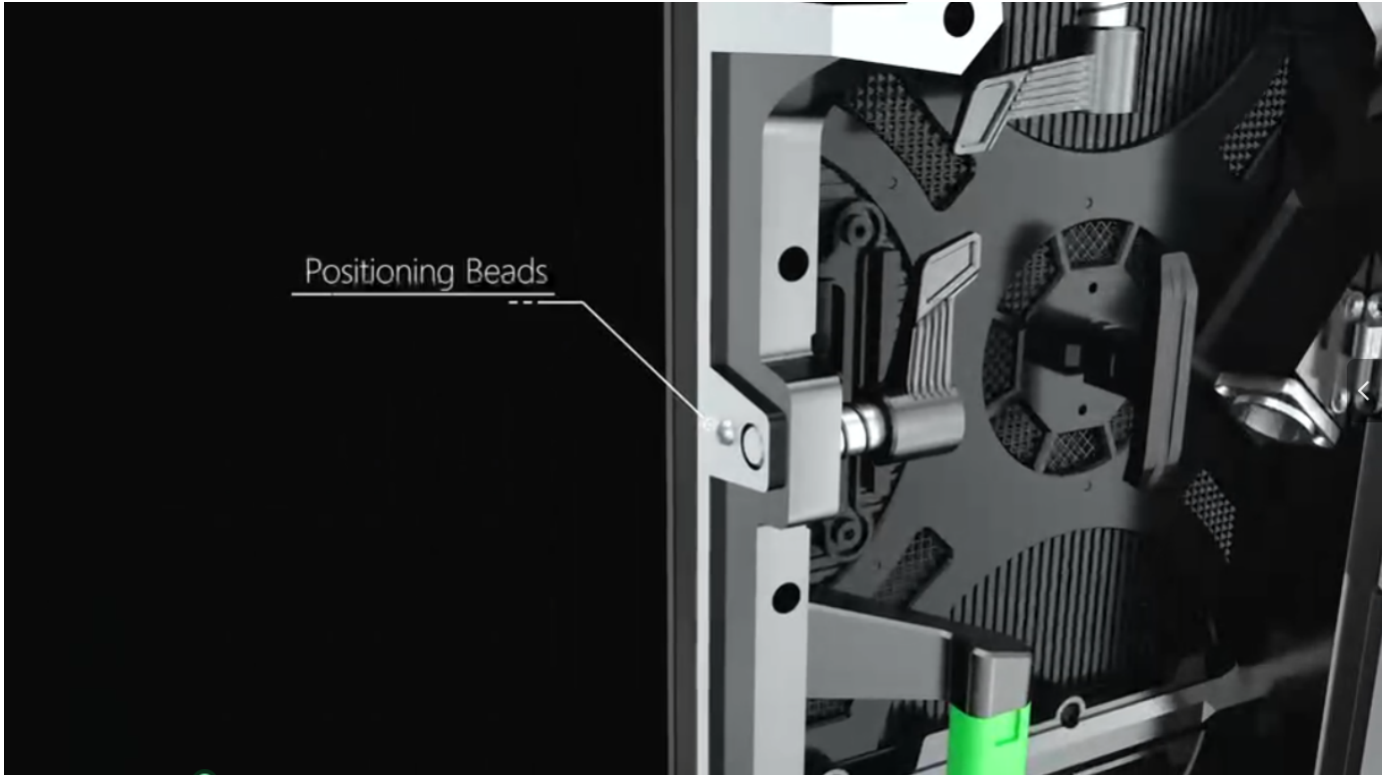

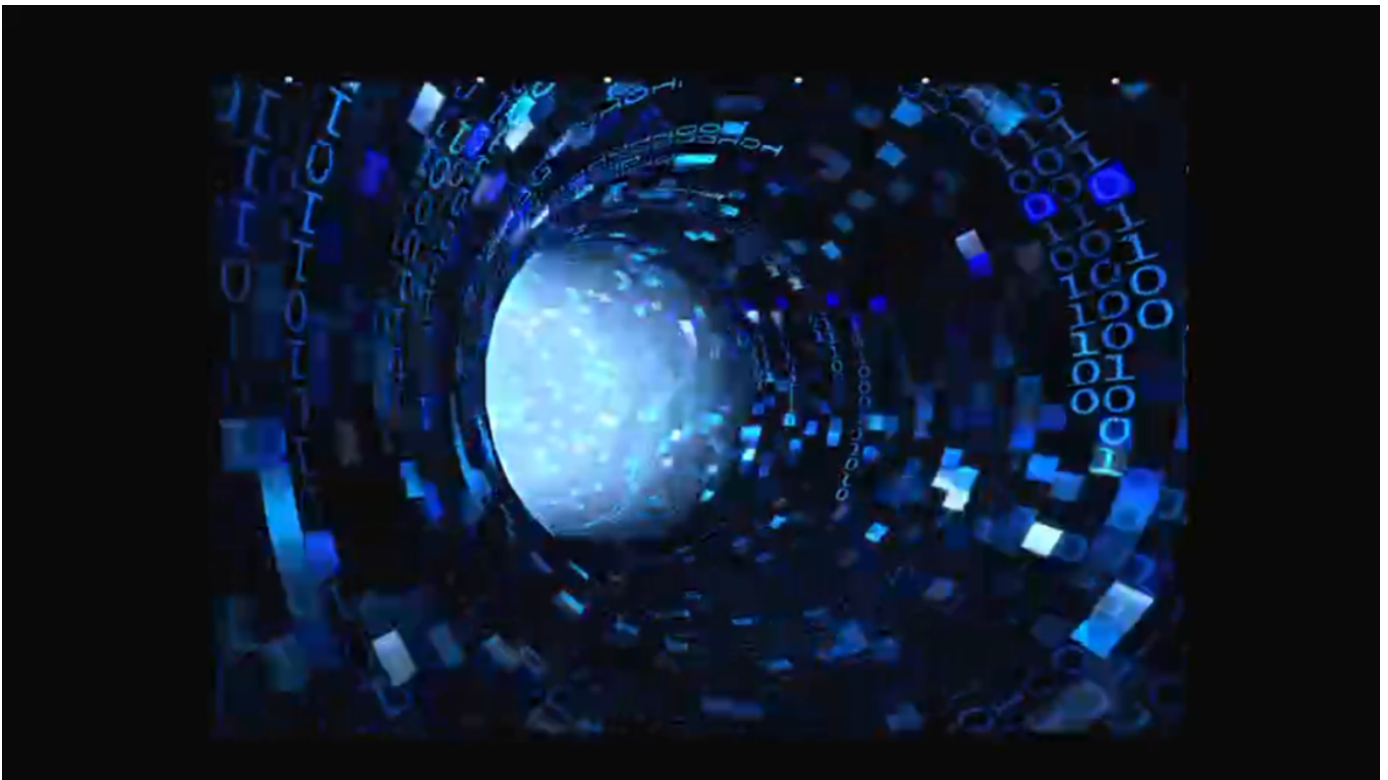
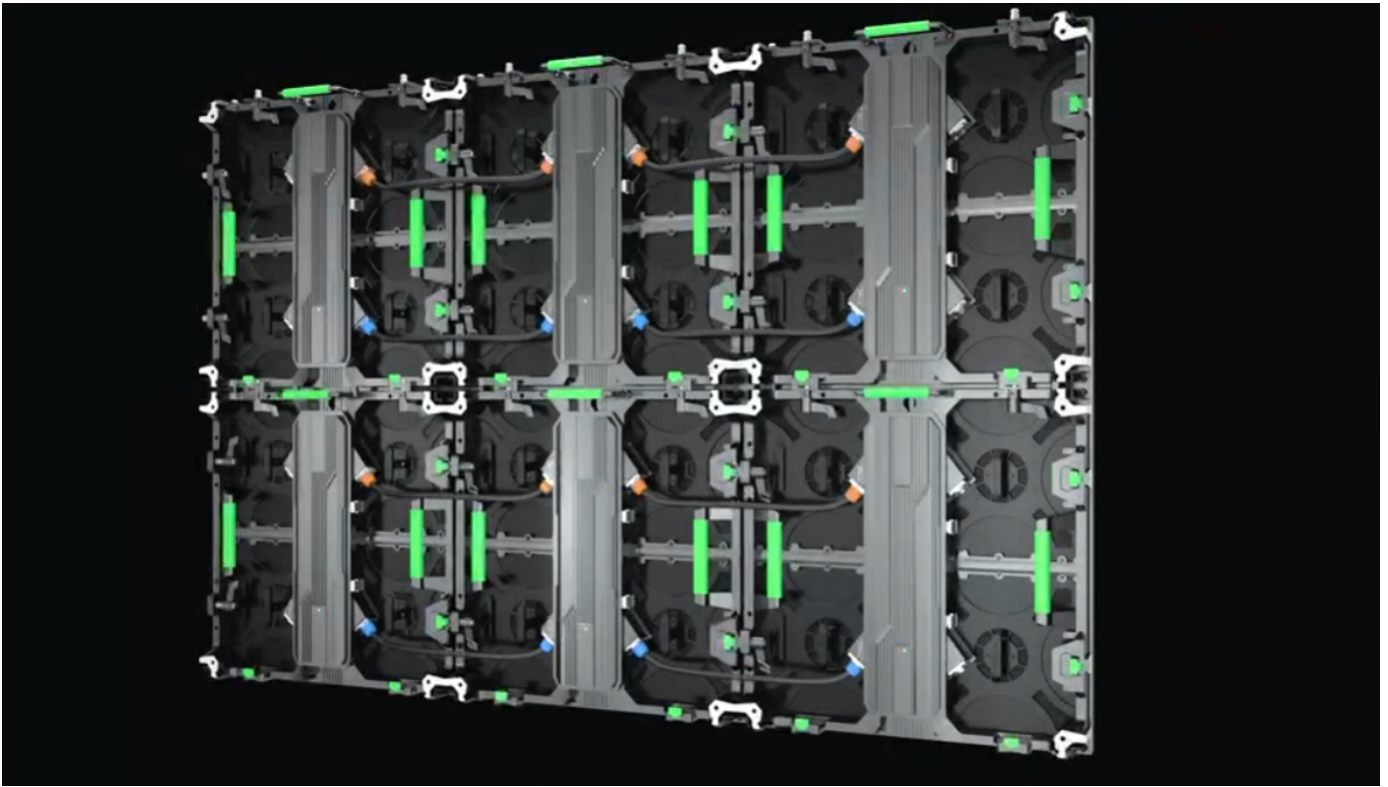

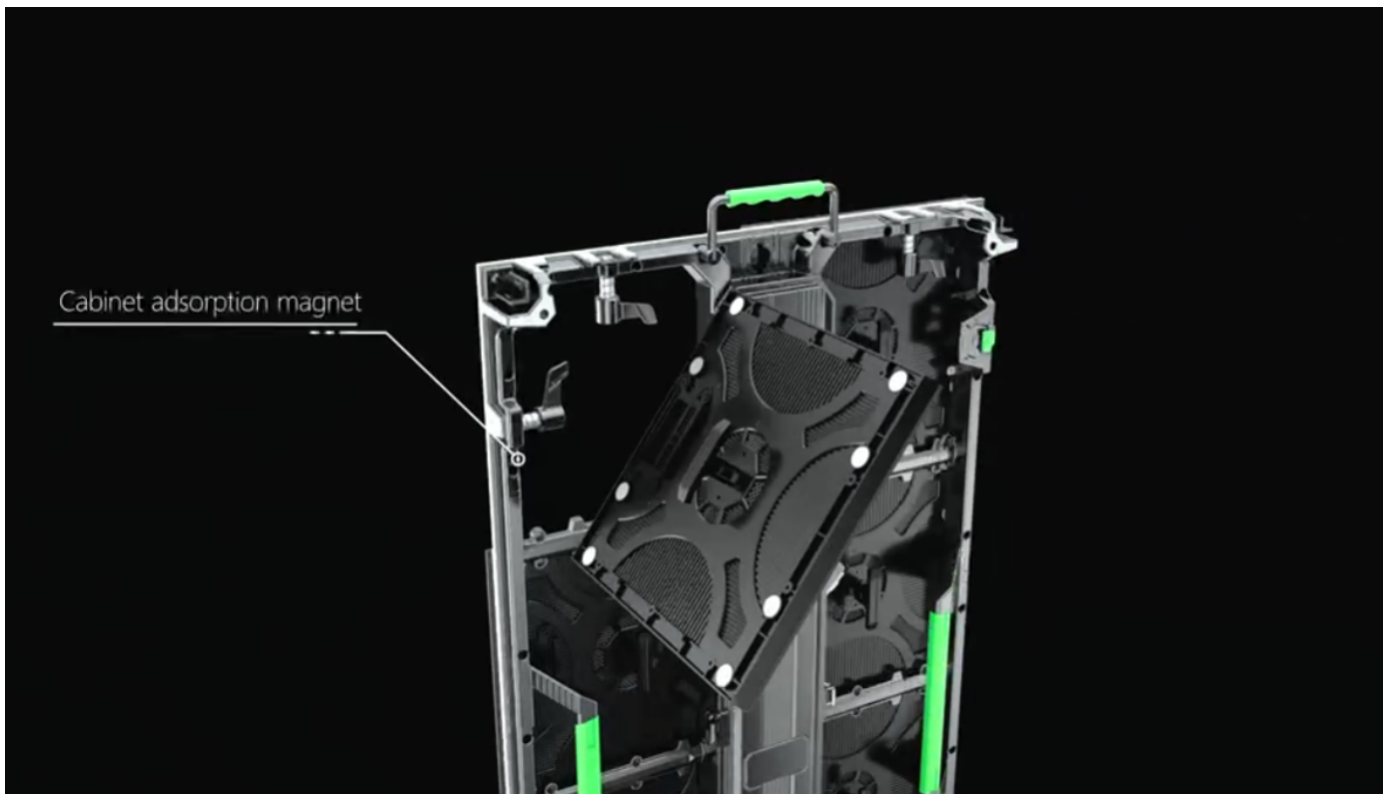
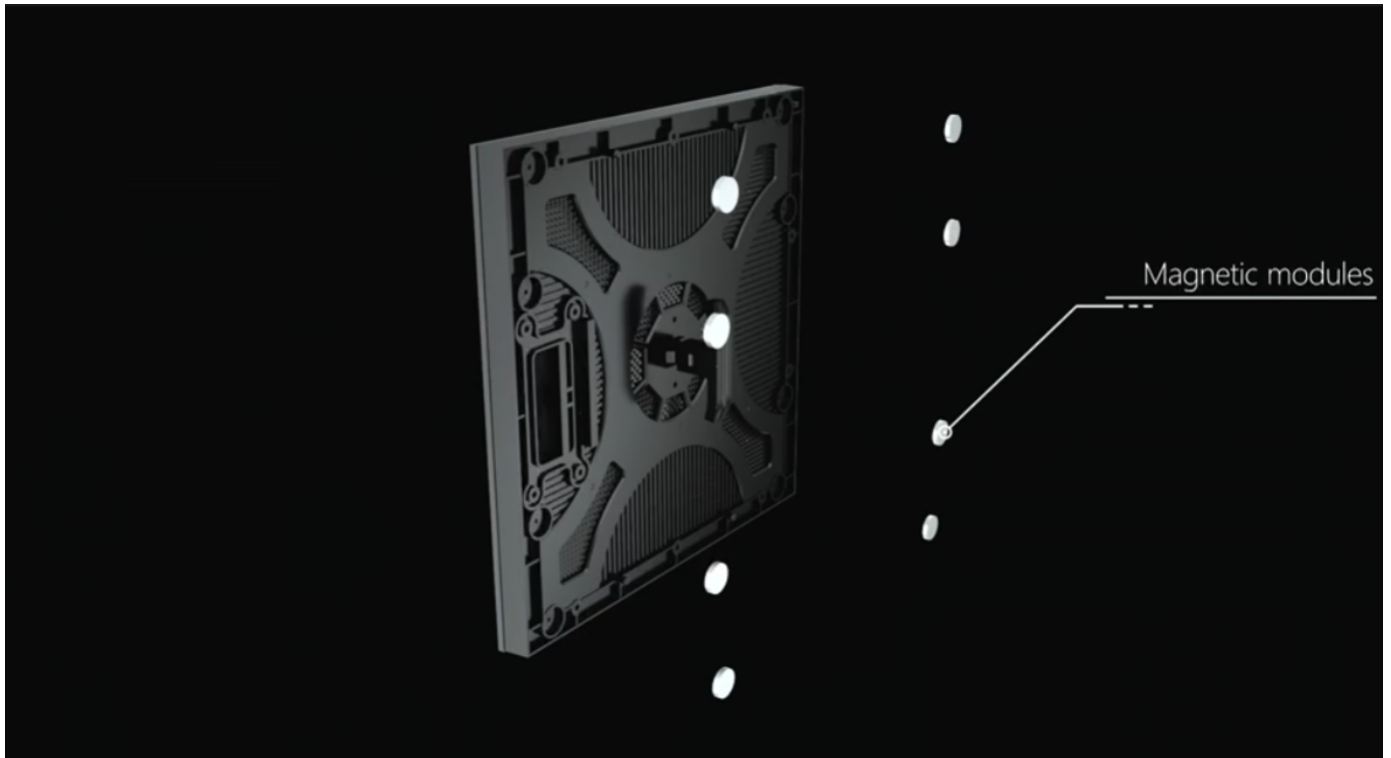



直形箱体 Straight cabinet

信号直插孔 Signal plug



弧形箱体 Curve cabinet



250x250mm 1000U

参数Spec.

P2/P2. 5/P2. 604/P3. 91/P4. 81/P5. 95

箱体尺寸Size	500mmX1000mmX55mm
箱体重量Weight	4.95g (铝门板/不含套件与电源/Aluminum door/Not include suite and power supply)
材质Material	铝Aluminum
单箱套件数Single cabinet suite number	每箱8个模组8 modules per cabinet
安装方式Installation	吊梁吊装及固定安装Crane girder hoisting and fixed installation
颜色Color	闪银Silver
使用环境Working environment	室内室外均可/Both indoor and outdoor
标准配件Standard accessories	1个门板、1个提手、2个定位销、1.3个连接片、4套快速锁(2套快速锁+2套弧度锁) 1 door、1 handle、2 positioning pins、1.3 Connection pieces、4 quick locks (2 quick locks+2 Radian locks)

细节展示The details show

<p>提手 The handle</p>	<p>定位销 The positioning pin</p>	<p>快速锁 Quick lock</p>	<p>弧度锁 (弧形箱体) Curve Lock (Curve cabinet)</p>	<p>连接片 Connection accessories</p>
--------------------------	------------------------------------	---------------------------	--	---------------------------------------

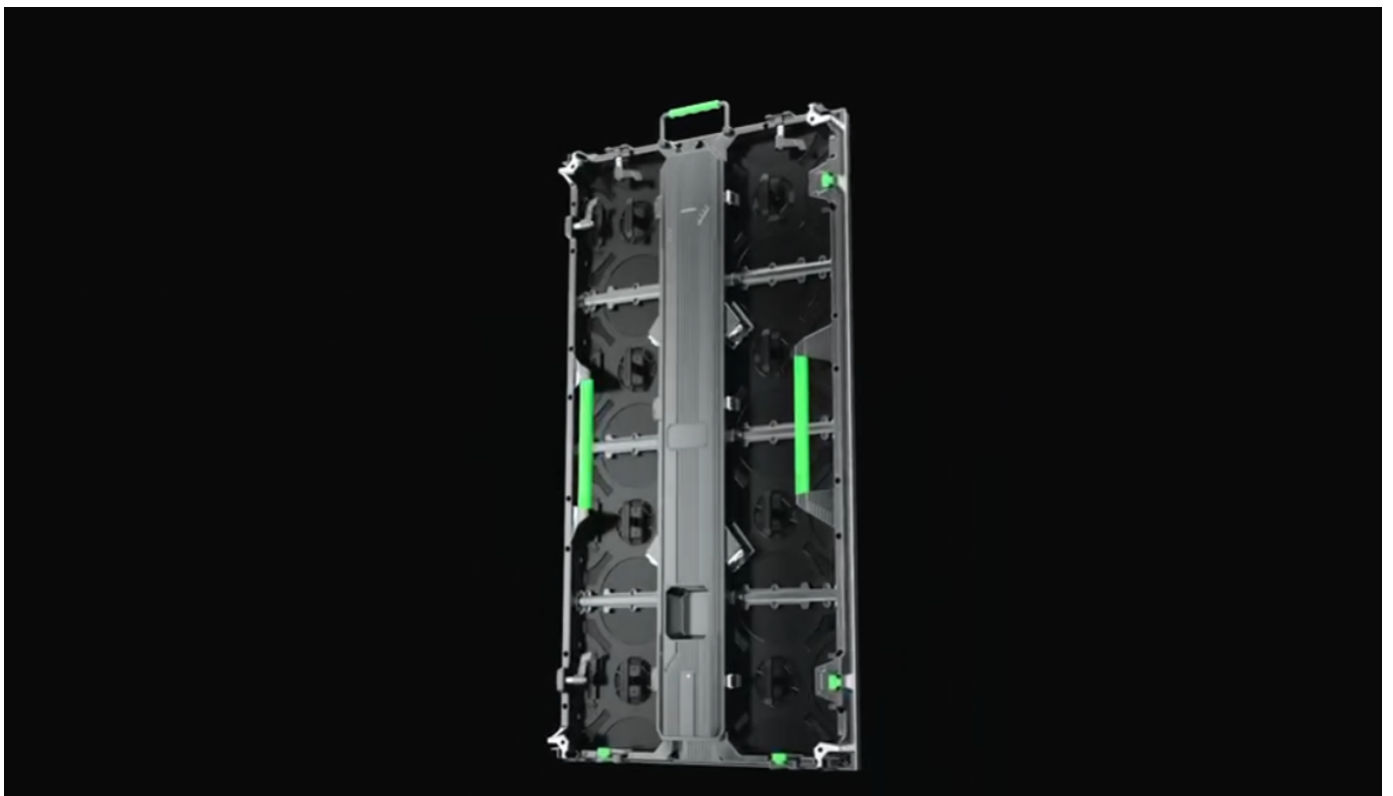

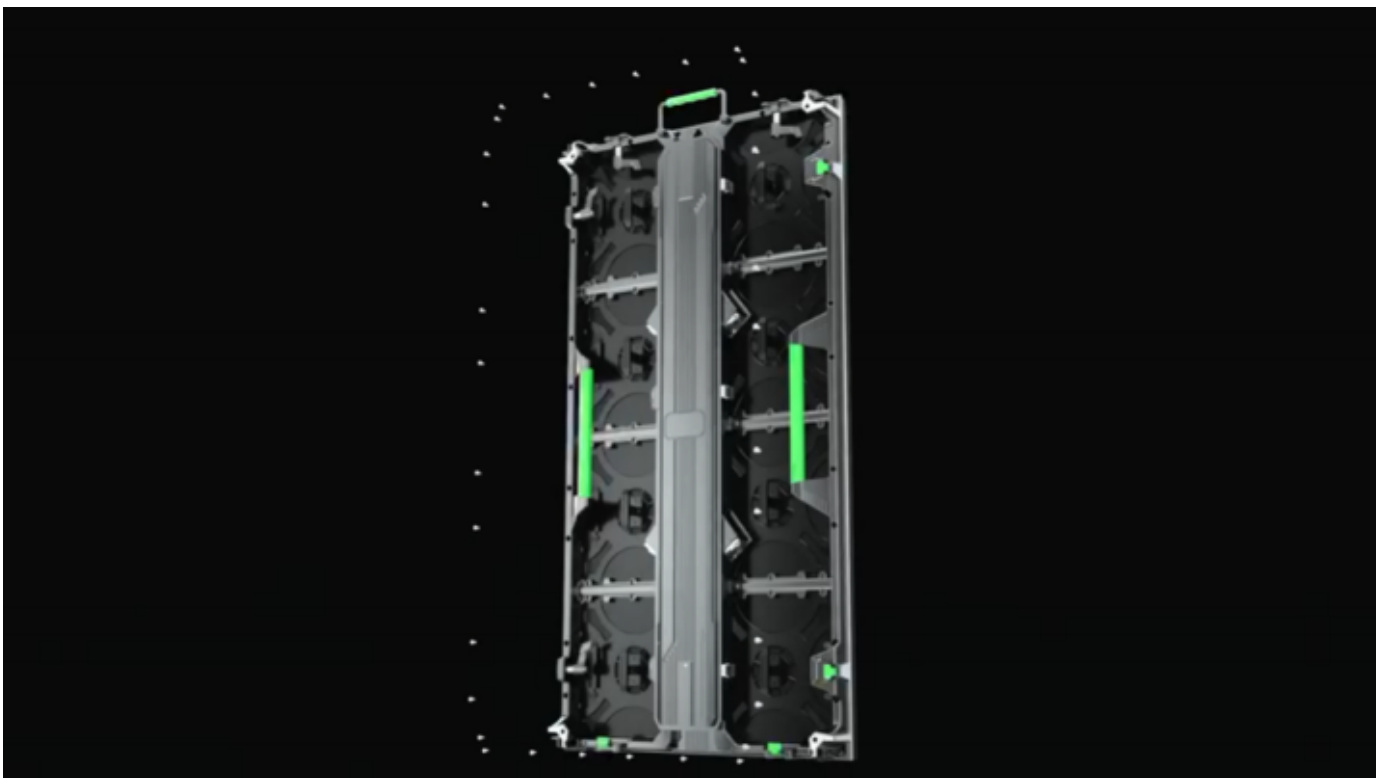
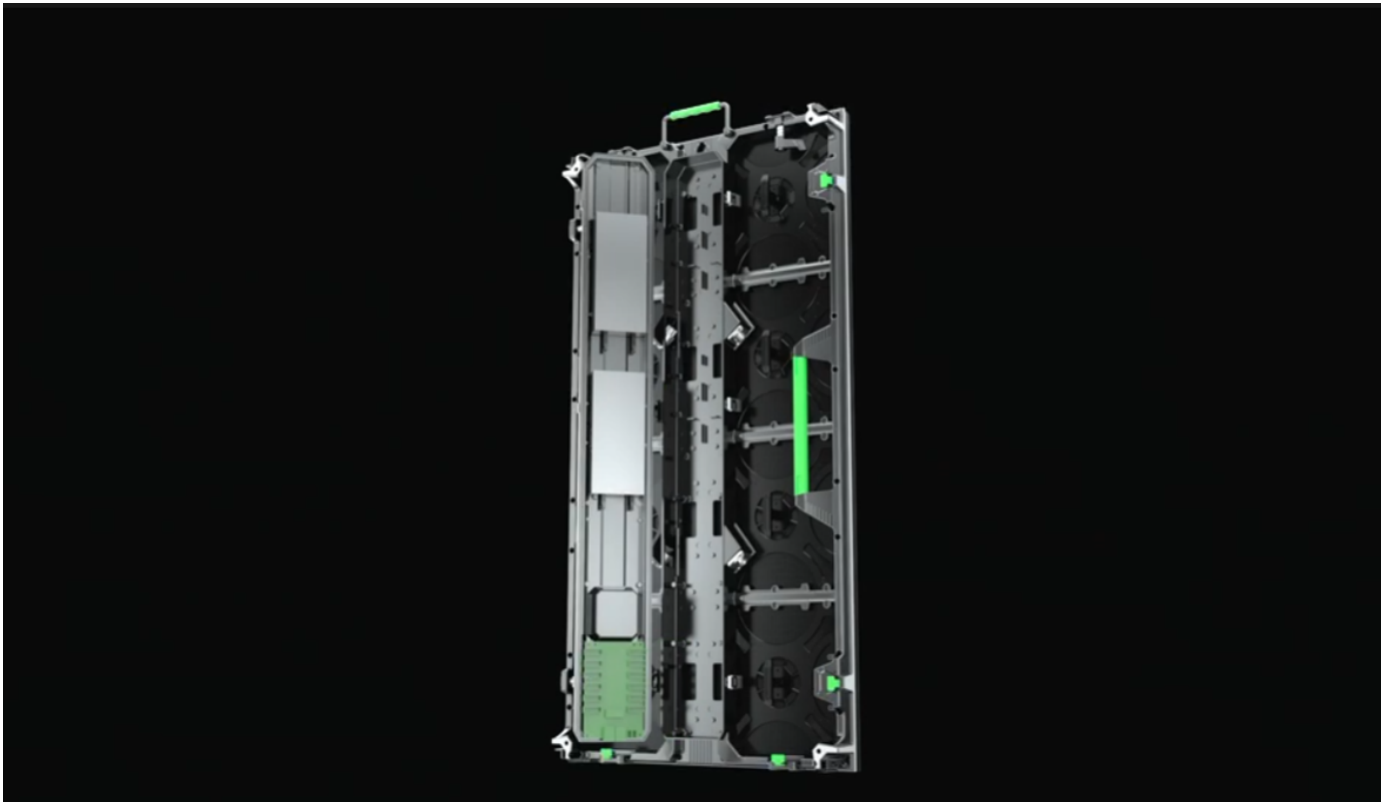

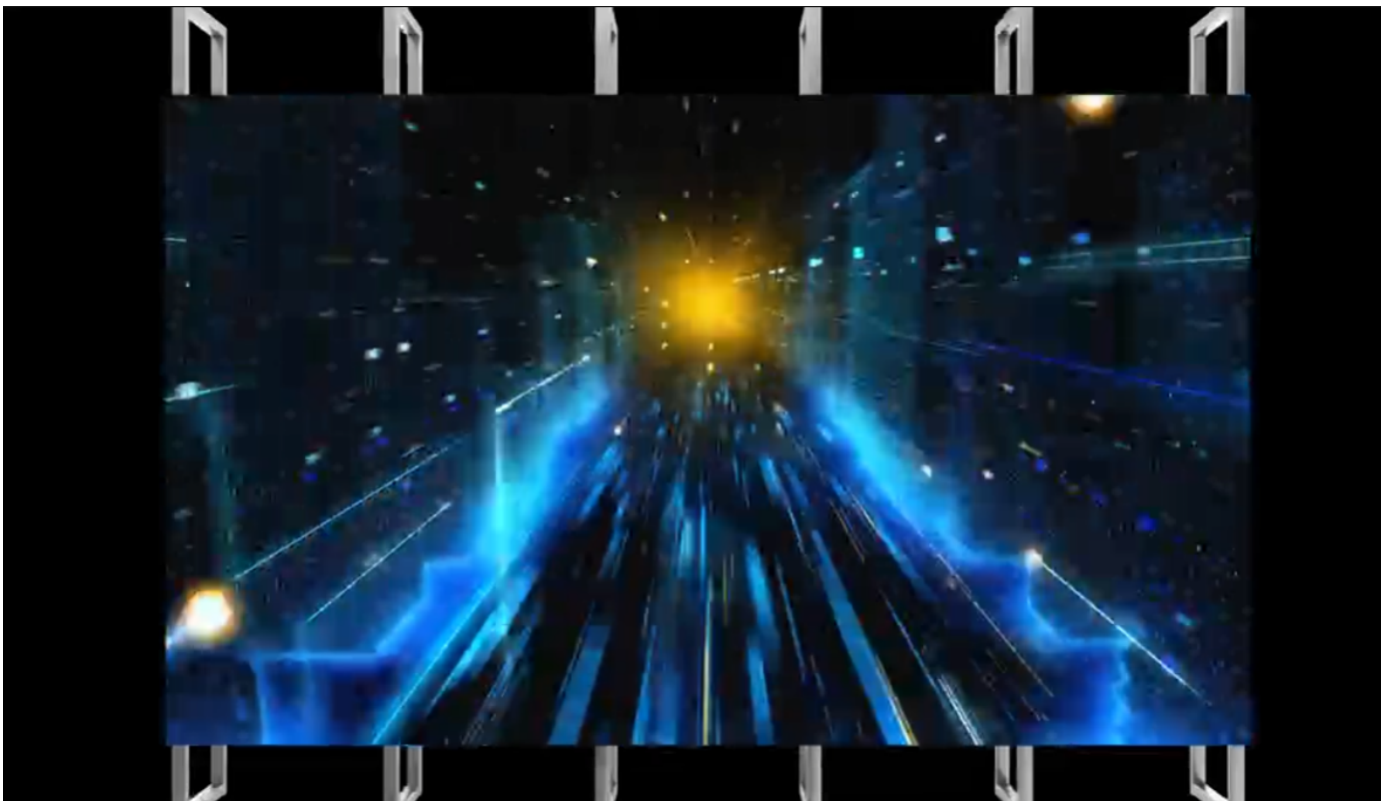

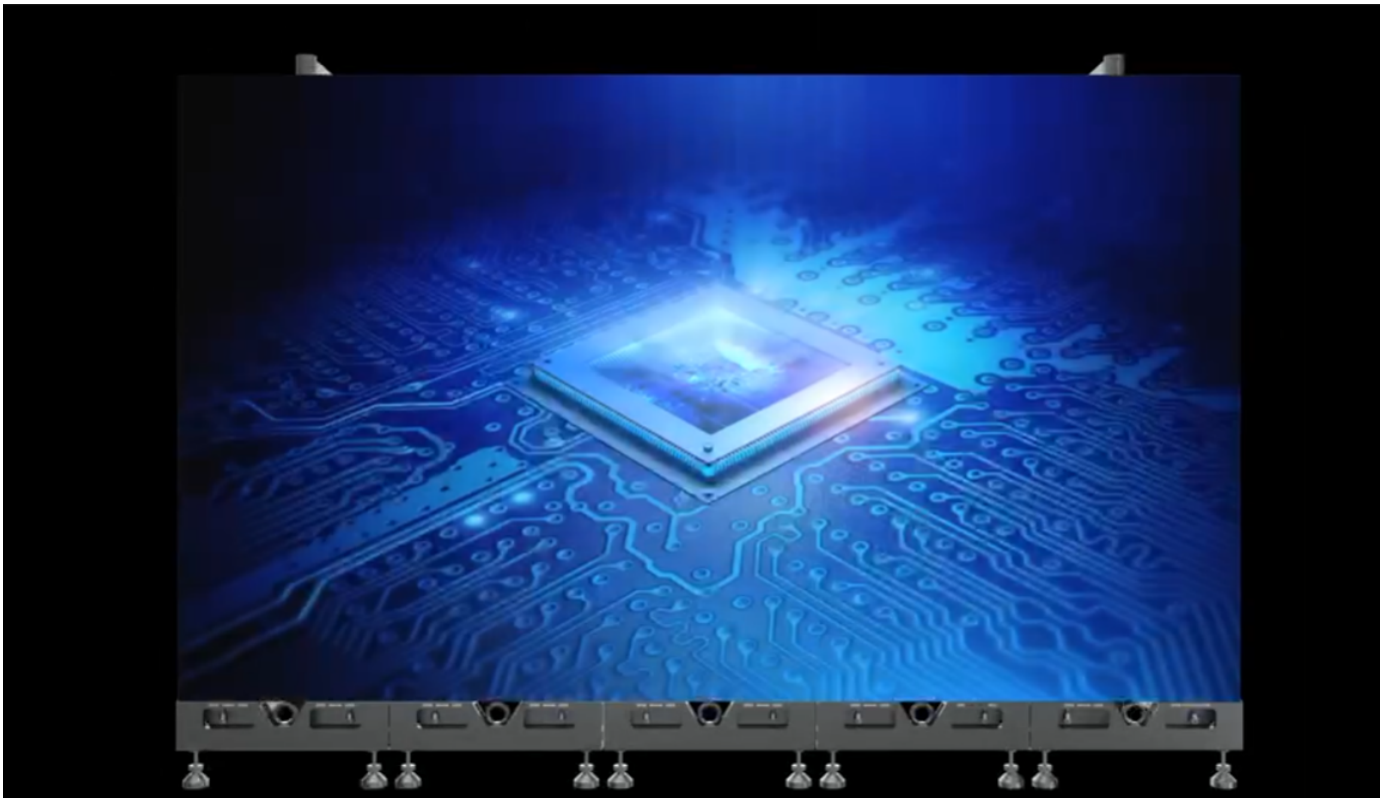
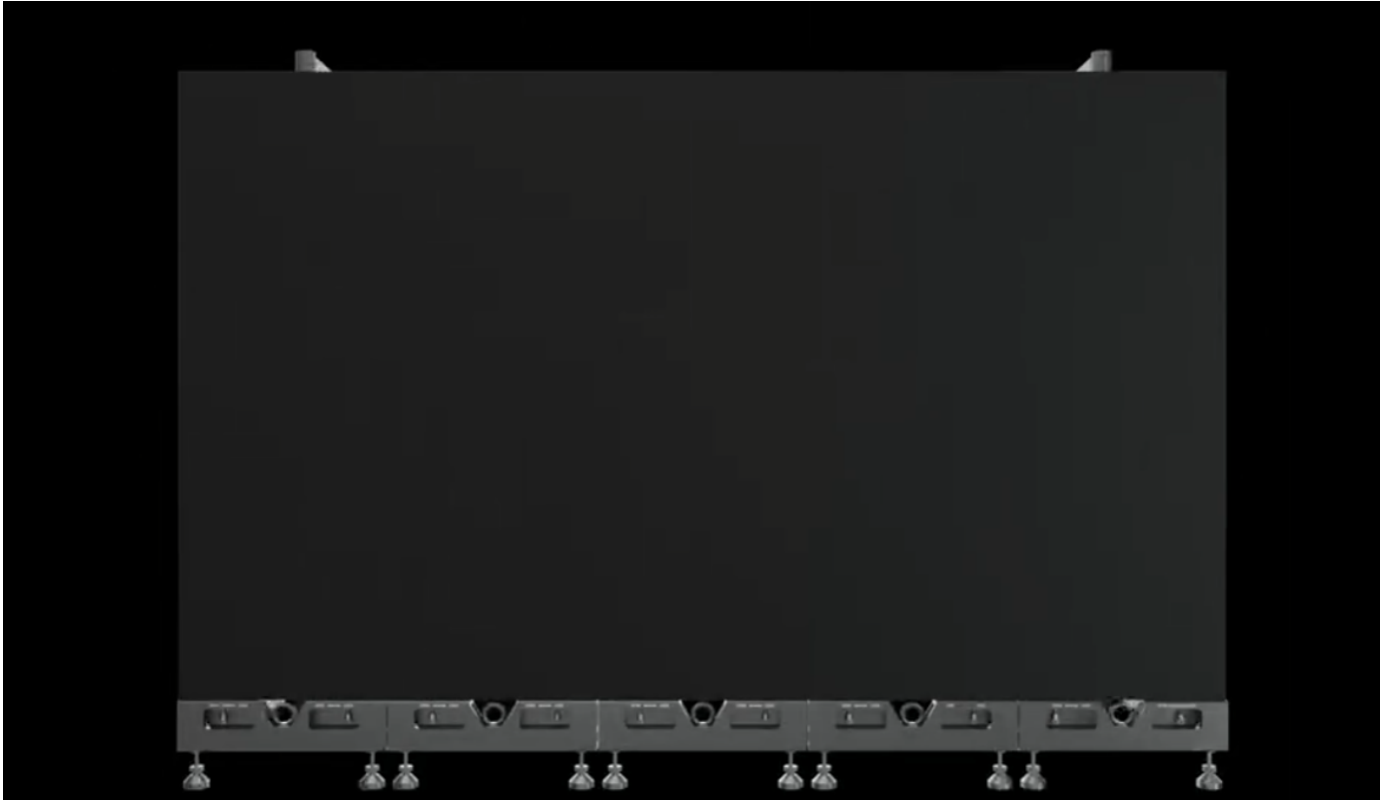

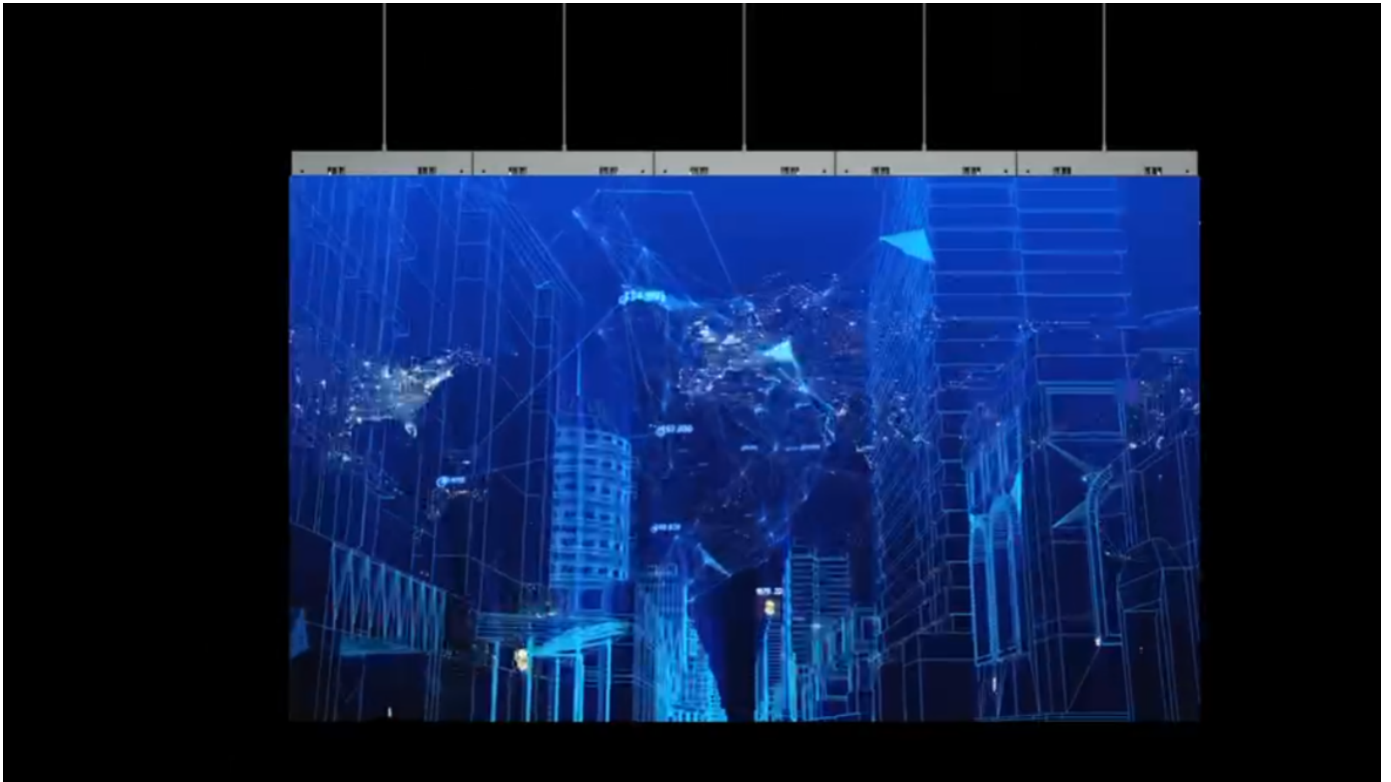
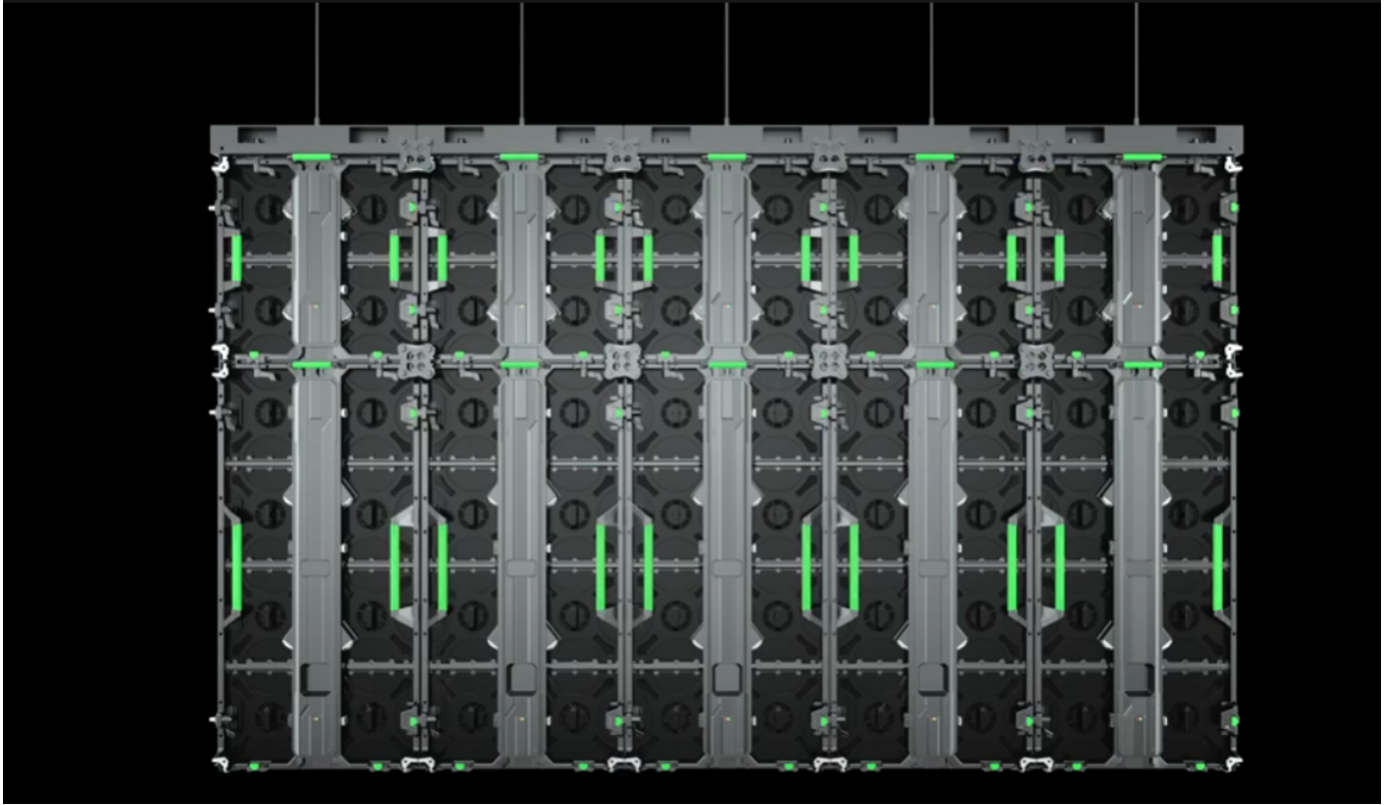

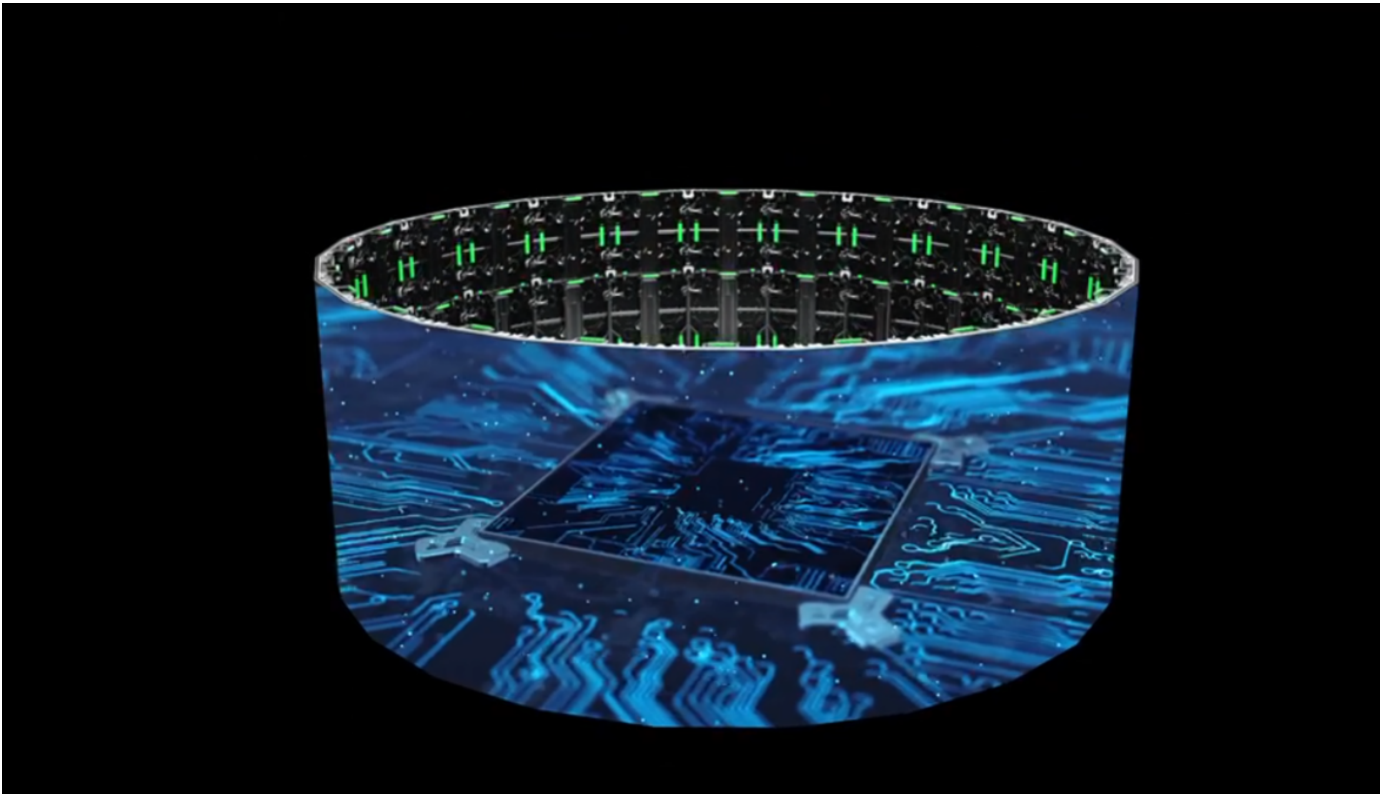
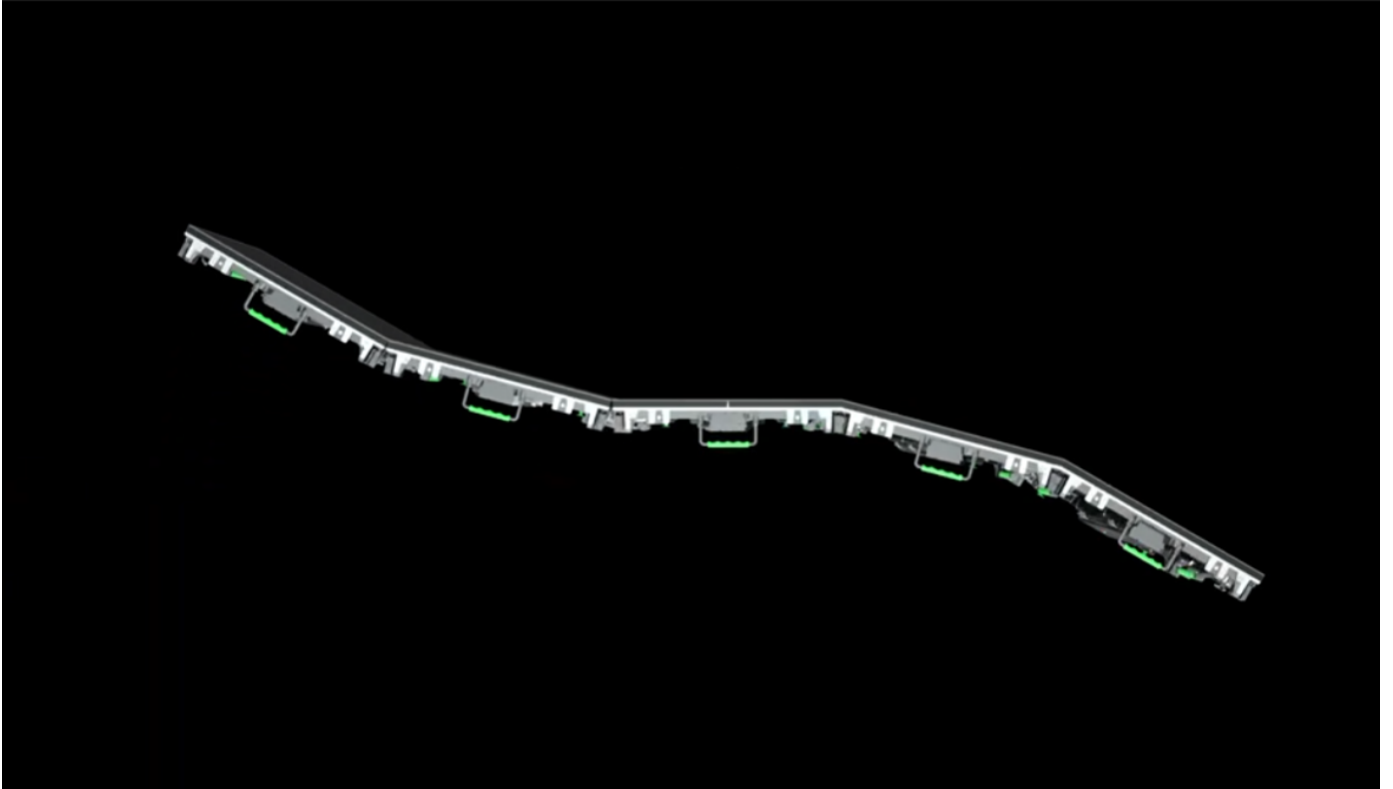

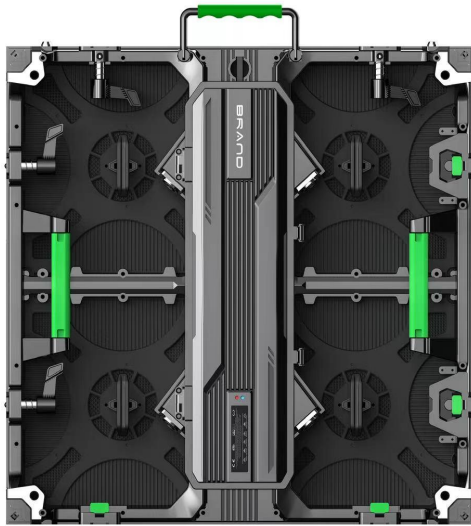

Parameters

Item	P1.56	P1.9	P2.6	P2.9	P3.91	P4.81
Pixel Pitch	1.56mm	1.953mm	2.604mm	2.976mm	3.91mm	4.81mm
LED Type	SMD1515	SMD1515	SMD1515	SMD2020	SMD2020	SMD2020
Module Resolution	160dots x 160dots	128dots x 128dots	96dots x 96dots	84dots x 84dots	64dots x 64dots	52dots x 52dots
Driving Mode	1/32scan	1/32scan	1/24scan	1/21scan	1/16scan	1/13scan
Module Pixels	25,600dots	16,384dots	9,216dots	7,056dots	4,096dots	2,704dots
Module Size(mm)	250 x 250	250 x 250	250 x 250	250 x 250	250 x 250	250 x 250
Cabinet Size(mm)	500 x 500/1000	500 x 500/1000	500 x 500/1000	500 x 500/1000	500 x 500/1000	500 x 500/1000
Cabinet Resolution(dots)	320 x 320/640dots	258 x 258/516dots	192 x 192/384dots	168 x 168/336dots	128 x 128/256dots	104 x 104/208dots
Pixel Density(dots/m ²)	409,600	282,144	147,456	112,896	65,536	43,264
Minimum Viewing Distance	≥1.5m	≥1.9m	≥2.6m	≥2.9m	≥3.9m	≥4.8m
Brightness	600~800nits	600~800nits	600~800nits	600~800nits	≥800nits	≥800nits
IP Grade	IP43	IP43	IP43	IP43	IP43	IP43
Refresh Rate	1920Hz~7,680Hz	1920Hz~7,680Hz	1920Hz~7,680Hz	1920Hz~7,680Hz	1920Hz~7,680Hz	1920Hz~7,680Hz
Gray Scale	12~16bits	12~16bits	12~16bits	12~16bits	12~16bits	12~16bits
Viewing Angle	160°/160°	160°/160°	160°/160°	160°/160°	160°/160°	160°/160°
Maximum Power Consumption	520(W/m ²)	520(W/m ²)	520(W/m ²)	520(W/m ²)	520(W/m ²)	520(W/m ²)
Average Power Consumption	175(W/m ²)	175(W/m ²)	175(W/m ²)	175(W/m ²)	175(W/m ²)	175(W/m ²)
Inout Voltage	AC110V~AC220V 50Hz/60Hz	AC110V~AC220V 50Hz/60Hz	AC110V~AC220V 50Hz/60Hz	AC110V~AC220V 50Hz/60Hz	AC110V~AC220V 50Hz/60Hz	AC110V~AC220V 50Hz/60Hz
Operating Temperature	-20℃~60℃	-20℃~60℃	-20℃~60℃	-20℃~60℃	-20℃~60℃	-20℃~60℃
Operating Humidity	10%~90%	10%~90%	10%~90%	10%~90%	10%~90%	10%~90%
Cabinet Material	Die-casting Aluminum	Die-casting Aluminum	Die-casting Aluminum	Die-casting Aluminum	Die-casting Aluminum	Die-casting Aluminum
Cabinet Weight	7.5kg/panel	7.5kg/panel	7.5kg/panel	7.5kg/panel	7.5kg/panel	7.5kg/panel
Operating System	Windows (Win7,Win8,etc.)	Windows (Win7,Win8,etc.)	Windows (Win7,Win8,etc.)	Windows (Win7,Win10,etc.)	Windows (Win7,Win10,etc.)	Windows (Win7,Win10,etc.)
Signal Source Compatibility	etc	etc	DVI,HDMI1.3,DP1.2,SDI,HDM2.0,etc	DVI,HDMI1.3,DP1.2,SDI,HDM2.0,etc	DVI,HDMI1.3,DP1.2,SDI,HDM2.0,etc	DVI,HDMI1.3,DP1.2,SDI,HDM2.0,etc